

OUTLIER

_technical data

Una lampada creata da una sfera di luce e un'asta unite in una composizione sbilanciata che definisce così il concetto di Outlier: un'entità che si differenzia dal resto del gruppo. Un'anomalia nella normalità.

Un'anomalia che crea unicità, un'unicità che crea ricercatezza e che dona all'ambiente quell'eccezione che attrae e che dà fascino.

Une lampe créée d'une sphère de lumière et d'une tige unique dans une composition déséquilibrée qui définit ainsi le concept d'Outlier: une entité singulière qui peut se démarquer du reste du groupe « Comme une anomalie dans la normalité ».

Anomalie qui crée l'unicité, une unicité qui crée du raffinement et qui donne à l'environnement cette exception qui attire et donne du charme.

Outlier contraste grandement avec les propositions habituellement imaginées.

A lamp created by a sphere of light and a rod united in an unbalanced composition that thus defines the concept of Outlier: an entity that differs from the rest of the group. An anomaly in normality.

An anomaly that creates uniqueness, a uniqueness that creates refinement and that gives the environment that exception that attracts and gives charm.

Una lámpara creada por una esfera de luz y una varilla unidas en una composición desequilibrada que define así el concepto de Outlier: una entidad que se diferencia del resto del grupo. Una anomalía en la normalidad.

Una anomalía que crea singularidad, una singularidad que crea refinamiento y que da al ambiente esa excepción que atrae y da encanto.

Eine Lampe, die aus einer Lichtkugel und einem Stab besteht, die in einer unausgewogenen Komposition vereint sind und so das Konzept von Outlier definieren: eine Einheit, die sich vom Rest der Gruppe unterscheidet. Eine Anomalie in der Normalität.

Eine Anomalie, die Einzigartigkeit schafft, eine Einzigartigkeit, die Raffinesse schafft und der Umgebung diese Ausnahme verleiht, die anzieht und Charme verleiht.

Лампа, созданная из светящейся сферы и стержня, объединенных в композицию с изменяемым балансом. Это и определяет концепцию Outlier: сущность, которая отличается от остальной группы. Аномалия в норме.

Аномалия, которая создает уникальность, уникальность, которая создает утонченность и придает окружающей среде ту исключительность, которая привлекает и придает очарование.

Rosone: bianco opaco.

Struttura: metallo nelle colorazioni bianco opaco, bronzo spazzolato, oro spazzolato.

Diffusore: vetro soffiato bianco latte satinato.

Canopy: matt white.

Frame: metal in the colors matt white, brushed bronze, brushed gold.

Diffuser: milk white satin blown glass.

Baldachin: weiß matt.

Struktur: metall in den Farben Weiß matt, Bronze gebürstet, Gold gebürstet.

Diffusor: milchweiß satiniertes mundgeblasenes Glas.

Rosette: blanc mat.

Structure: métal dans les couleurs blanc mat, bronze brossé, or brossé.

Diffuseur: verre soufflé satiné blanc lait.

Florón: blanco mate.

Estructura: metal en los colores blanco mate, bronce cepillado, oro cepillado.

Difusor: vidrio soplado satinado blanco leche.

Основание: матовое белое.

Структура: металл матового белого цвета, брашированная бронза, брашированное золото.

Рассеиватель: молочно-белое сатинированное выдувное стекло.



06: Bianco opaco/
Matte white

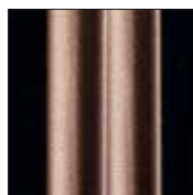

32: Bronzo spazzolato/
Brushed bronze



33: Oro spazzolato/
Brushed gold

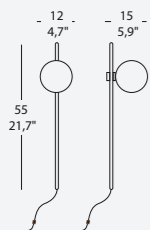

OUTLIER PA_C

1 x MAX 4,8W G9 LED

CE F IP 20 EAC

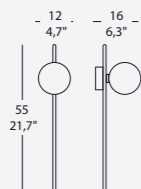

OUTLIER PA_M

1 x MAX 4,8W G9 LED

CE F IP 20 EAC

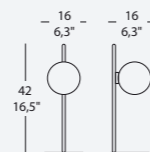

OUTLIER CO

1 x MAX 4,8W G9 LED

CE F IP 20 EAC

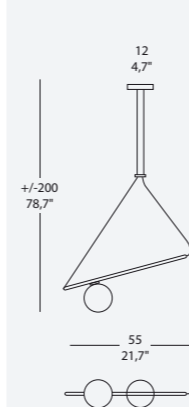
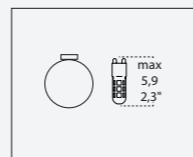

OUTLIER S01

1 x MAX 4,8W G9 LED

CE F IP 20 EAC

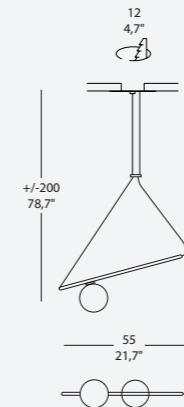

OUTLIER IN1

1 x MAX 4,8W G9 LED

CE F IP 20 EAC

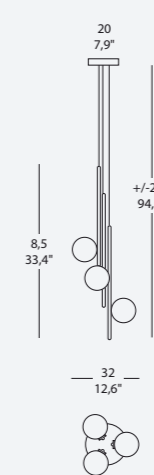

OUTLIER S03

3 x MAX 4,8W G9 LED

CE F IP 20 EAC

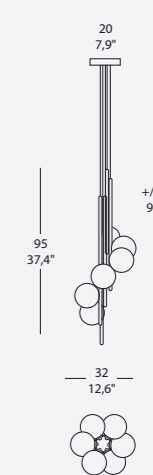

OUTLIER S06

6 x MAX 4,8W G9 LED

CE F IP 20 EAC

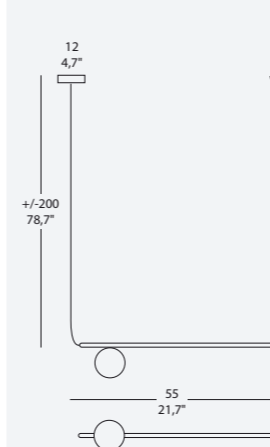

OUTLIER SO L INT

1 x MAX 4,8W G9 LED

CE F IP 20 EAC

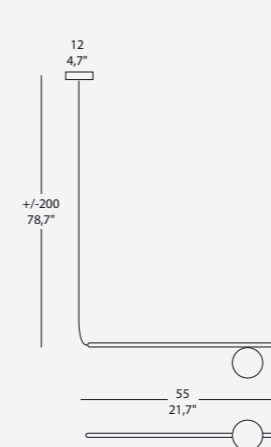

OUTLIER SO L EXT

1 x MAX 4,8W G9 LED

CE F IP 20 EAC

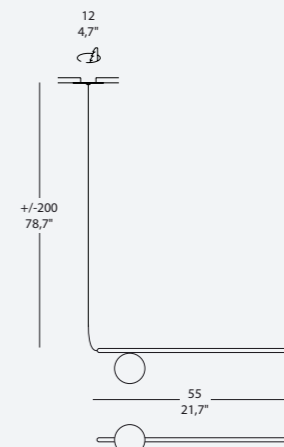

OUTLIER IN L INT

1 x MAX 4,8W G9 LED

CE F IP 20 EAC

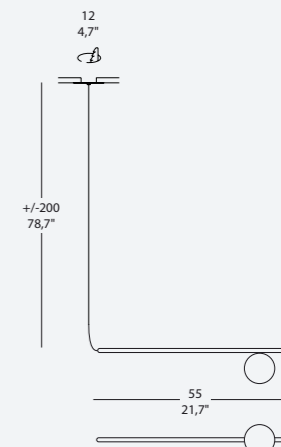

OUTLIER IN L EXT

1 x MAX 4,8W G9 LED

CE F IP 20 EAC

ESEMPIO DI COMPOSIZIONE/EXAMPLE OF COMPOSITION

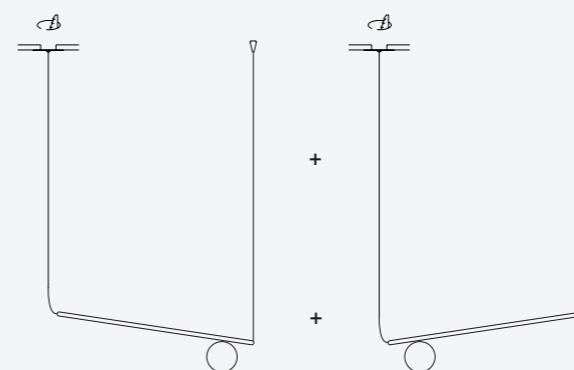

N° 4 OUTLIER IN L INT

N° 5 OUTLIER IN L EXT



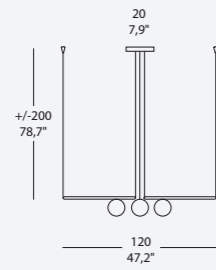
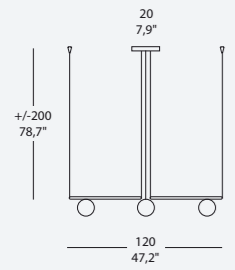

OUTLIER LA3 EXT
3 x MAX 4,8W G9 LED 
CE  IP 20 EAC

OUTLIER LA3 INT
3 x MAX 4,8W G9 LED 
CE  IP 20 EAC

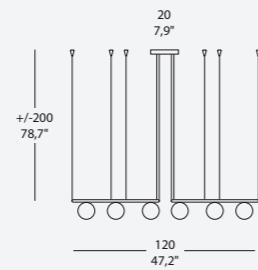
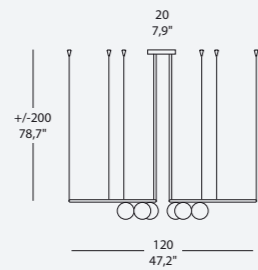
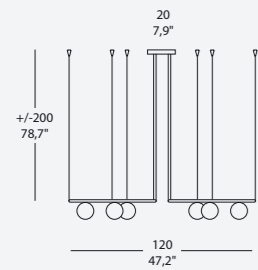

OUTLIER LA6 EXT
6 x MAX 4,8W G9 LED 
CE  IP 20 EAC

OUTLIER LA6 INT
6 x MAX 4,8W G9 LED 
CE  IP 20 EAC

OUTLIER LA6 ALT
6 x MAX 4,8W G9 LED 
CE  IP 20 EAC

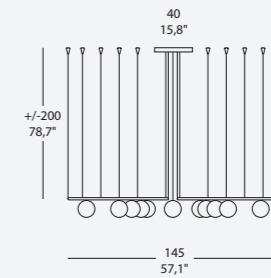
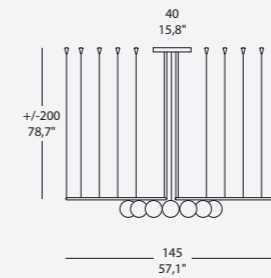
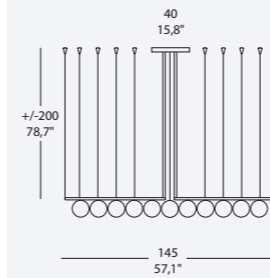

OUTLIER LA12 EXT
12 x MAX 4,8W G9 LED 
CE  IP 20 EAC

OUTLIER LA12 INT
12 x MAX 4,8W G9 LED 
CE  IP 20 EAC

OUTLIER LA12 ALT
12 x MAX 4,8W G9 LED 
CE  IP 20 EAC